

SURFACE MOUNT LED PURE GREEN, 1206 IL PACKAGE

BIVAR

SM1206NPGC-IL

- ◆ Industry Standard 1206 Package
- ◆ RoHS Compliant
- ◆ Water Clear Inner Lens
- ◆ High Luminous Intensity
- ◆ Narrow Viewing Angle
- ◆ Ideal for Status Indication, Display, and Backlighting

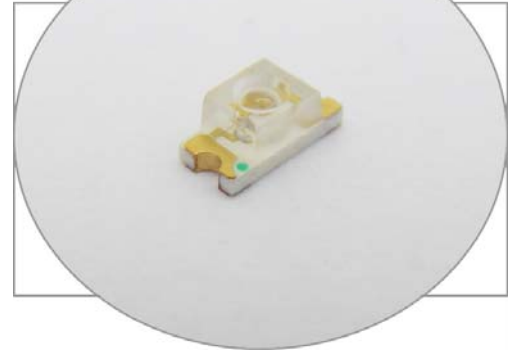

Bivar Surface Mount 1206 Inner Lens package LED may be used in nearly any lighting or indication application. The water clear inner lens provides a narrow viewing angle and high luminous intensity making it suitable for small scale applications such as display, backlighting, and general indication. Low power consumption and excellent long life reliability are ideal for battery powered equipment. Wide variety of wavelength and intensity combinations are available to meet any illumination need. The SM1206-IL LED is packaged in standard tape and reels for pick and place assemblies.

Part Number	Material	Emitted Color	Peak Wavelength λ_p (nm) TYP.	Lens Appearance	Luminous Intensity (mcd) TYP.	Viewing Angle
SM1206NPGC-IL	InGaN/SiC	PURE GREEN	523	Water Clear	1550	30°

Outline Dimensions



Outline Drawings Notes:

1. All dimensions are in inches [millimeters].
2. Standard tolerance: ± 0.010 " unless otherwise noted.



Bivar reserves the right to make changes at any time without notice.

SURFACE MOUNT LED PURE GREEN, 1206 IL PACKAGE



Absolute Maximum Ratings

$T_A = 25^\circ\text{C}$ unless otherwise noted

Power Dissipation	100 mW
Forward Current (DC)	25 mA
Peak Forward Current ¹	100 mA
Reverse Voltage	5 V
Operating Temperature Range	-30 ~ +80°C
Storage Temperature Range	-40 ~ +85°C
Lead Soldering Temperature (3 mm from the base of the epoxy bulb) ²	260°C

Notes: 1. 10% Duty Cycle, Pulse Width \leq 0.1 msec. 2. Solder time less than 5 seconds at temperature extreme.

Electrical / Optical Characteristics

$T_A = 25^\circ\text{C}$ & $I_F = 20$ mA unless otherwise noted

Part Number	Forward Voltage (V) ¹			Recommend Forward Current (mA)			Reverse Current (μA)	Dominant Wavelength (nm) ²			Luminous Intensity I_v (mcd)			Viewing Angle $2\theta_{1/2}$ (deg)
	MIN	TYP	MAX	MIN	TYP	MAX	MAX	MIN	TYP	MAX	MIN	TYP	MAX	TYP
SM1206NPGC-IL	/	3.0	4.2	/	20	/	10	/	525	/	1000	1550	/	30

Notes: 1. Tolerance of forward voltage : $\pm 0.05\text{V}$. 2. Tolerance of dominant wavelength : $\pm 5.0\text{nm}$.

Bivar reserves the right to make changes at any time without notice.

SURFACE MOUNT LED PURE GREEN, 1206 IL PACKAGE



Typical Electrical / Optical Characteristics

$T_A = 25^\circ\text{C}$ unless otherwise noted

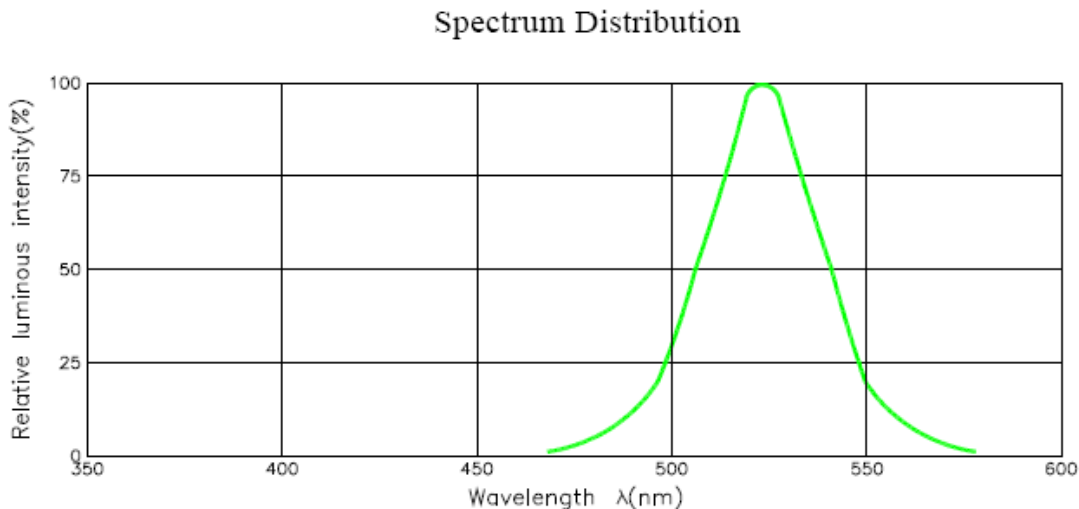
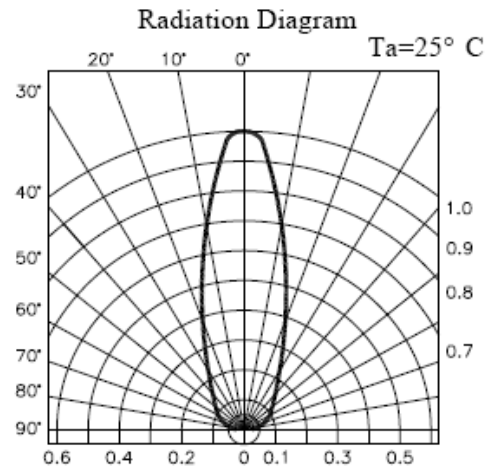
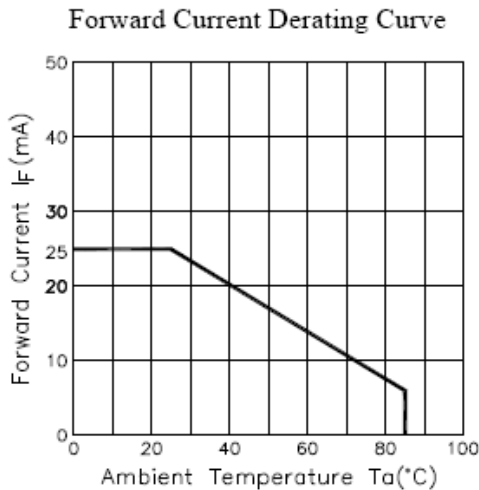
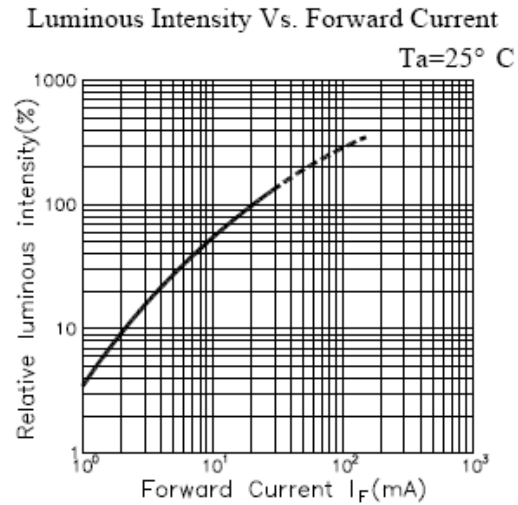
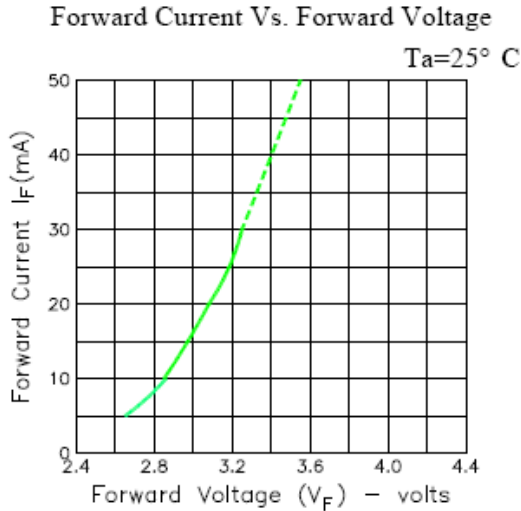

Bivar reserves the right to make changes at any time without notice.

SURFACE MOUNT LED PURE GREEN, 1206 IL PACKAGE



Recommended Soldering Conditions



Tape and Reel Dimensions

Note: 3000 pcs/Reel

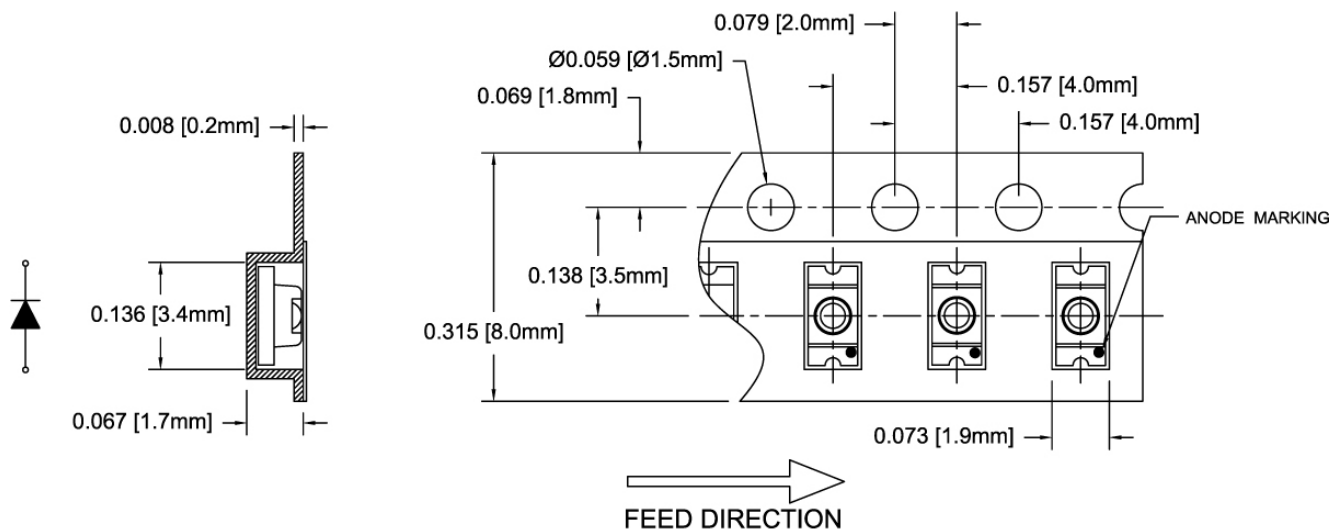

Outline Drawings Notes:

1. All dimensions are in inches [millimeters].
2. Standard tolerance: $\pm 0.010''$ unless otherwise noted.

Bivar reserves the right to make changes at any time without notice.

SURFACE MOUNT LED PURE GREEN, 1206 IL PACKAGE



Outline Drawings Notes:

1. All dimensions are in inches [millimeters].
2. Standard tolerance unless otherwise noted: X.XXX ± 0.010"
X.X ± 0.1"

Packaging and Labeling Plan

Note: 1 Reel / Bag

Vacuum and Heat Sealed
ESD/MBB Bag

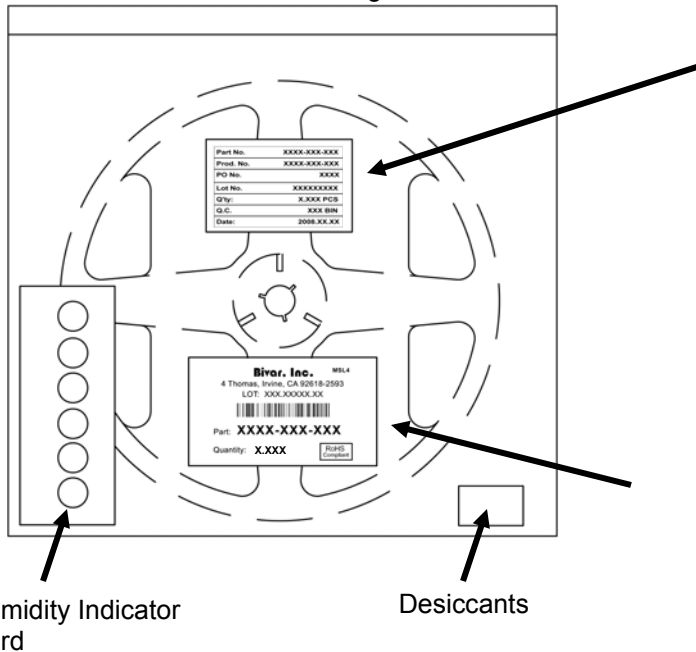

Part No.	XXXX-XXX-XXX
Prod. No.	XXXX-XXX-XXX
PO No.	XXXX
Lot No.	XXXXXXXXXX
Q'ty:	X.XXX PCS
Q.C.	XXX BIN
Date:	2008.XX.XX

Internal Quality Control

Bivar, Inc. MSL4

4 Thomas, Irvine, CA 92618-2593
LOT: XXX.XXXXX.XX



Part: **XXXX-XXX-XXX**

Quantity: **X.XXX**

RoHS
Compliant

Bivar Standard Packaging Label

Bivar reserves the right to make changes at any time without notice.

Mouser Electronics

Authorized Distributor

Click to View Pricing, Inventory, Delivery & Lifecycle Information:

[BIVAR:](#)

[SM1206NPGC-IL](#)